

**HELLER**

**TOP LOAD WASHING MACHINE**

**Model:HWM8TL**

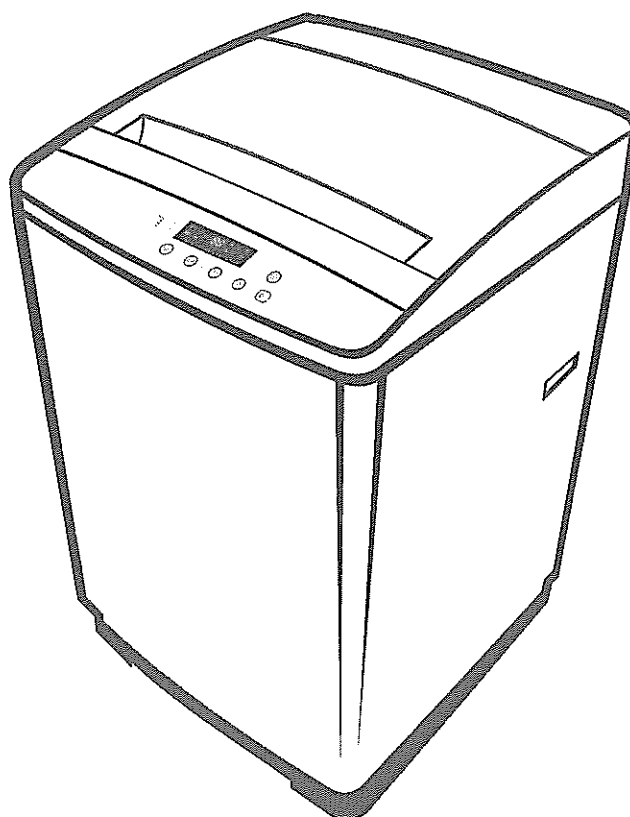

**INSTRUCTION MANUAL**



---

Please read instructions carefully before using

# CONTENTS

1. SAFETY WARNING .....	1
2. PARTS IDENTIFICATION.....	2
3. ACCESSORIES .....	2
4. CONTROL PANEL.....	3
5. SPECIFICATIONS.....	3
6. INSTALLATION.....	4
7. DETERGENT CONTAINER.....	8
8. OPERATION.....	9
9. PROGRAMS.....	11
10. MAINTENANCE.....	12
11. TROUBLE SHOOTING .....	13
12. ELECTRICAL DIAGRAM .....	14

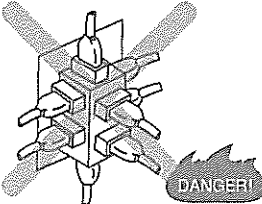
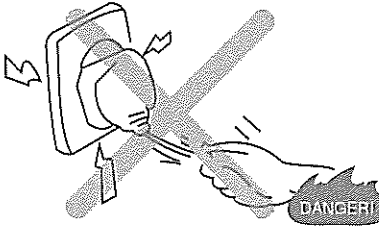
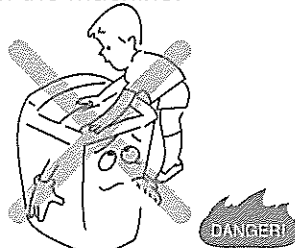
# SAFETY WARNING

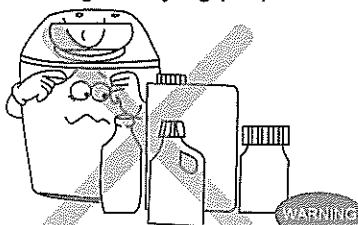
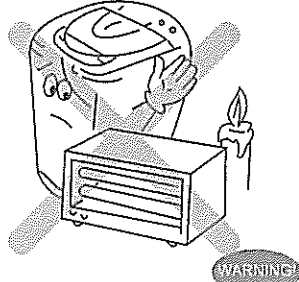
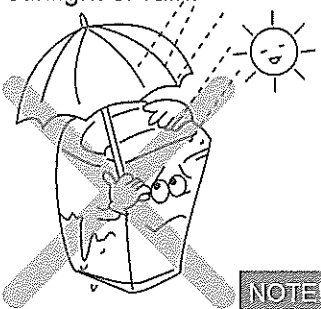
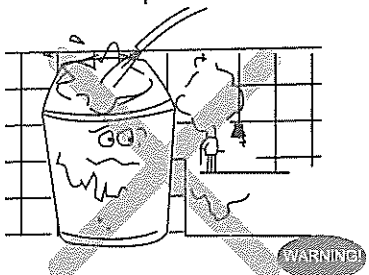
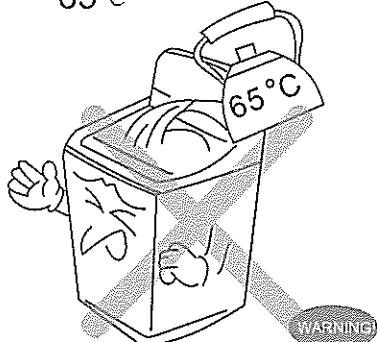
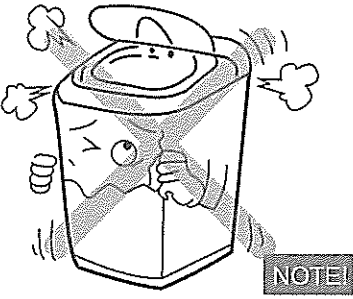
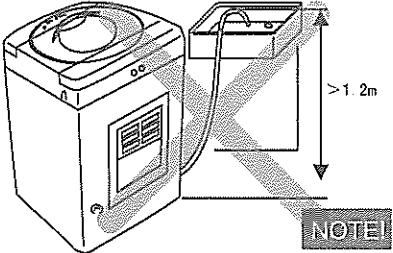
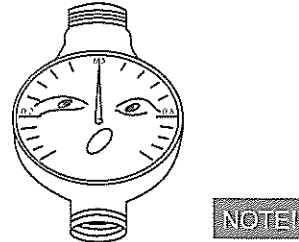
<p>■ Do not overload circuits. Do not use an adapter. Do not use an extension cord.</p> 	<p>■ Do not only hold the cord while pulling out the plug.</p> 	<p>■ Do not let children to play with the machine.</p> 
<p>■ Do not put hands into the rotating tub.</p> 	<p>■ Do not clean the body of washer with volatile solvent such as petrol and methane. Also, do not pour these solvents into the tub for washing or drying purposes.</p> 	<p>■ Keep the washing machine away from fire or heat source.</p> 
<p>■ Do not expose washing machine to direct sunlight or rain.</p> 	<p>■ Do not place the washing machine in a damp place and do not pour water onto the control panel.</p> 	<p>■ Never use water above 65 °C</p> 
<p>■ Make sure the lid is closed especially during spin.</p> 	<p>■ The highest point of the drain hose must be in the height of 0.7m~1.2m above floor level.</p> 	<p>■ Don't switch on the power if the water pressure is lower than 0.03Mpa and higher than 0.85MPa.</p> 

# PARTS IDENTIFICATION

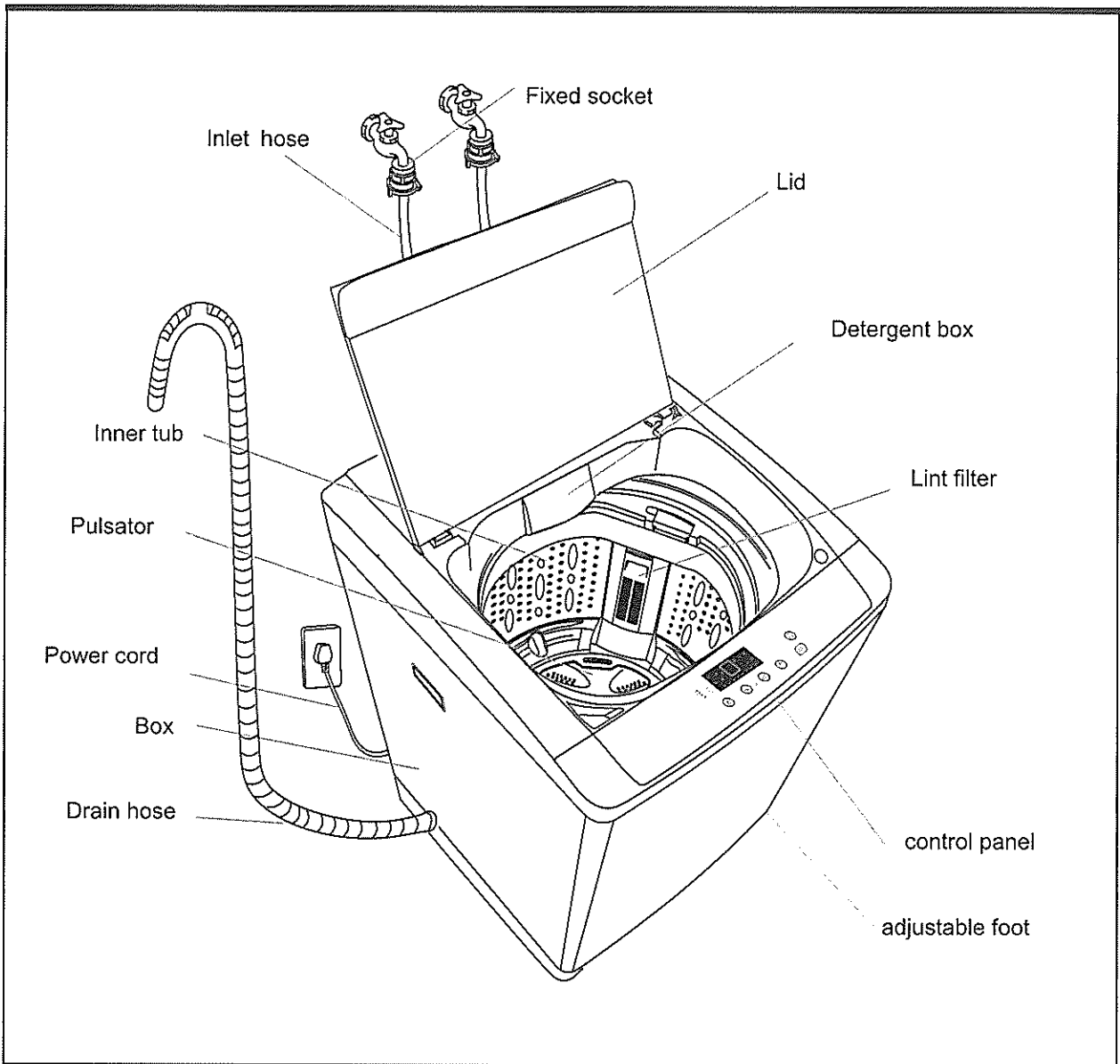

## ACCESSORIES

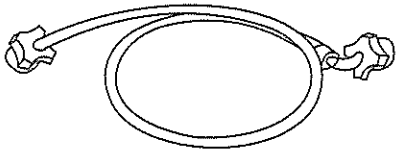
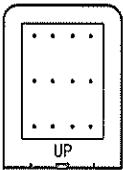
Inlet hose	Noise and mice-proof plate
	 <p>(2 screws)</p>
2PCS	1PC

# CONTROL PANEL

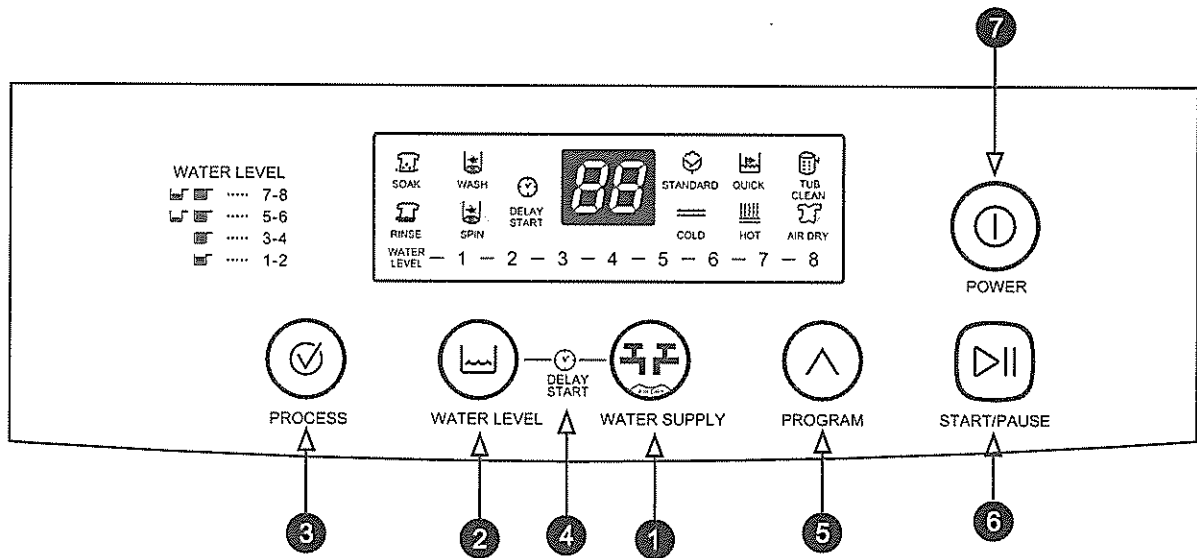

1. Water supply selector/Air dry: Press this button to select water temperature or the time of air dry
2. Water level button: Press this button to select water level.
3. Process button: Press this buttons to select the process you need.
4. Delay start Preset button Hold the water level of key, then press water supply can be set up into the reservation status time of delay start.
5. Program button Press this buttons to select the program you need.
6. Start/Pause button Press this button to start/pause the washing machine.
7. Power button: Press this button to turn on/off the washing machine. Do not turn on the washing machine again until 3 minutes later after it is turned off. The washing machine will turn off at once automatically when the program finish, and it will turn off automatically if you do not press the start button to start the machine within 10 minutes after press the power button.

## SPECIFICATIONS

Rated voltage	220-240V~	Rated frequency	50Hz
Rated input power	420W	Net weight	34 KG
Rated wash capacity	8.0 KG	Rated spin capacity	8.0 KG
Water pressure	0.03MPa-0.85MPa		
Dimension	570mmX580mmX985mm		

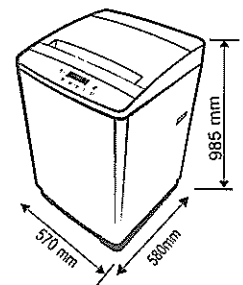

# INSTALLATION

## Insert the noise-proof plate into the washing machine base

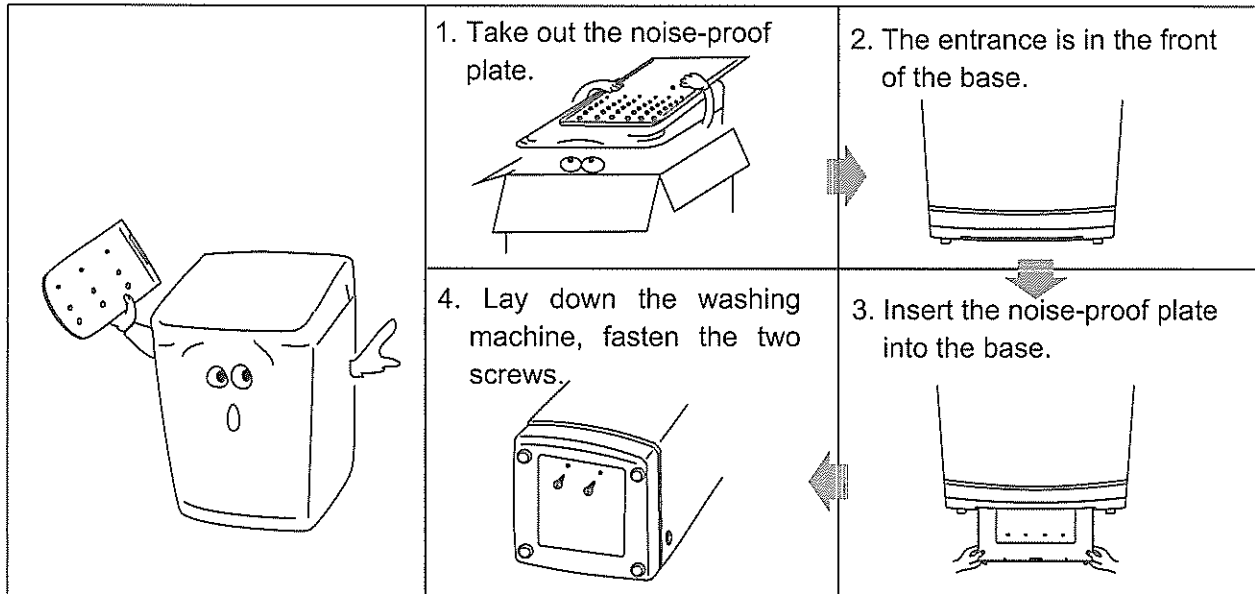

## Install the washing machine

Install the washing machine on a firm and level surface, use the level adjustment knob to regulate the adjustable foot until the washing machine is stable.

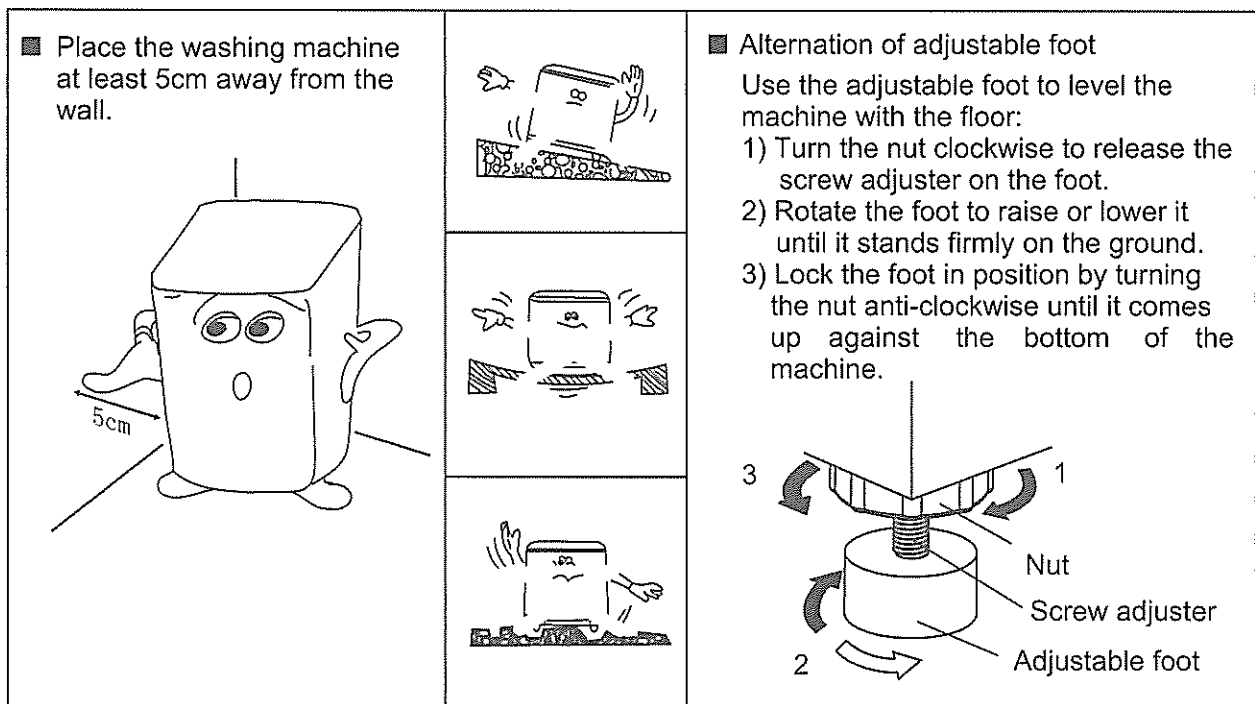

# INSTALLATION

---

## Connection of the drain hose

### Connection of the drain hose

Insert the end of the drain hose into the hook shelf, and hang the drain hose over a drain outlet (bath tub, sink, etc.).

**Note:** The highest point of the drain hose must be in the height of 0.7m~1.2m above floor level, otherwise, the washer can not work normally.

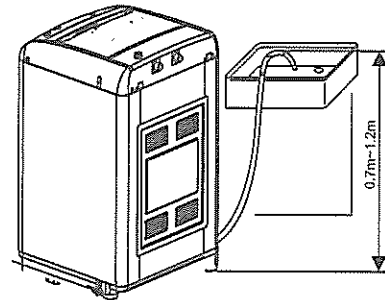

## Water supply requirements

### Water Temperature

#### Cold :

Recommended cold water temperature is 10~23.8°C.

#### Hot :

Recommended hot water temperature is 50~60°C.

#### Warm:

Mixture of hot and cold water. (Warm water temperature is dependent upon the water temperature and the pressure of both the hot and cold water supply lines.)

#### **IMPORTANT:**

Owner should turn off water supply whenever there will be an extended period of non-use.

### Water Pressure

Do not operate the washer when the water pressure is lower than 0.03MPa or higher than 0.85MPa to avoid damage of the inlet system.

# INSTALLATION

## Faucet: Connection of the inlet hose

The faucet must be with G3/4" standard screw thread. If not, it is impossible to connect the inlet hose properly.

**NOTE:** water supply faucets should be readily accessible to permit turning them off when washer is not being used.

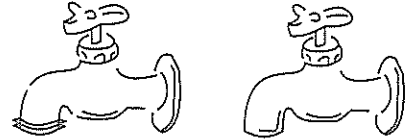

## Installation and connection of the Inlet hose

### Note:

The washing machine is to be connected to the water mains using new hose-sets supplied with the appliance, old hose-sets should not be re-used.

Refer to Section on Water Supply Requirements before connecting water inlet hoses.

### I . About faucet

1. Connect the water inlet hose to the connector by turning the connecting nut.

### . About washing machine

**A:** If you just have one water supply line (cold or hot water), connect the inlet hose to the cold water connector. Do not unscrew the lid of hot water connector.

### IMPORTANT:

In this situation you can not set wash temperature to **WARM OR HOT**.

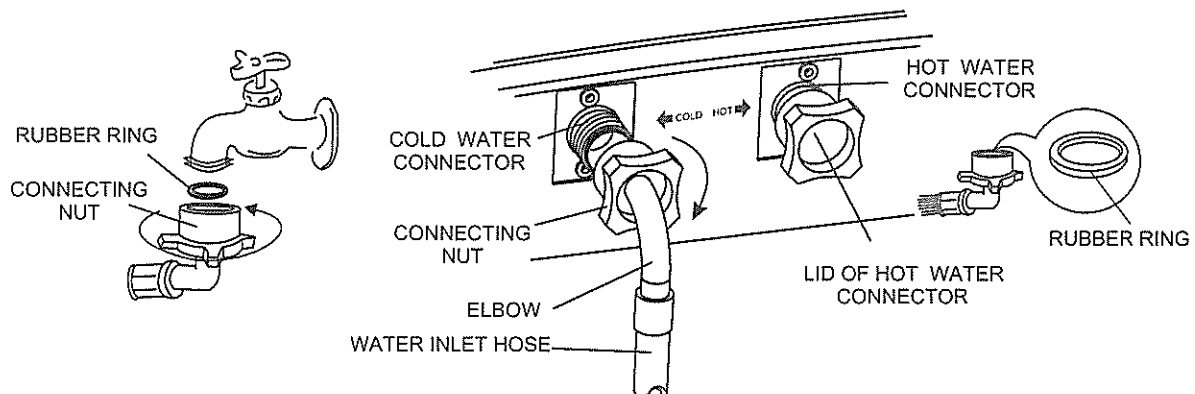

To prevent water leakage, please ensure the connecting nut is tightened securely. If water leakage, check the nut whether it is filled with rubber ring.

**B:** If you have both cold and hot water supplied, connect the inlet hose by cold to cold and hot to hot.

Note: Use Teflon tape when connecting the inlet hoses to the tap connections.



# INSTALLATION

Unscrew the lid of hot water connector, and then connect the another water inlet hoses to the hot water connector by turning the connecting nut.

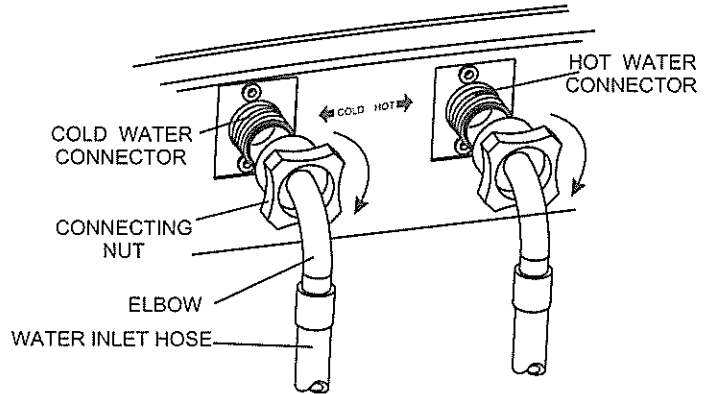

## Dismantling the inlet hose

Dismantling the hose directly may cause water to splash since the water pressure is still high, even after the faucet has been turn off, so please take off the hose according to the following steps:

- 1) Turn off the faucet.
- 2) Turn on the power and keep the machine in operation.
- 3) Turn off the power after approximately 5 seconds.
- 4) Loosen the nuts on both sides of inlet hose.

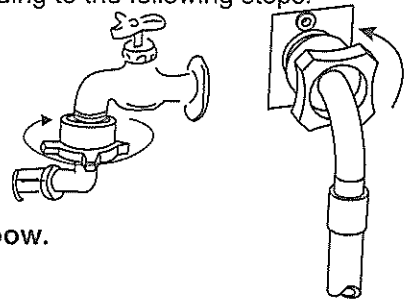

- If the machine is used frequently, it is unnecessary to take off inlet hose to avoid damage to the nut at the elbow.
- Always close the tap when unit is not in use.

## Connection of the power cord

### Note:

- The socket should have assembled the 5A fuse.
- Use three pins socket, where the earth is connected.

### Warning:

- The earth wire of the washing machine is set in the plug, don't try to modify it.
- The socket should have reliable earth wire. If no earth wire in socket, please call the technician to assemble.
- Never try to connect the earth wire of the washing machine together with that of gas pipe or water pipe, telephone cord or lightening rod.
- Do not use the damaged cord because it could cause electrical leakage and fire.
- In case cord is damaged, call the local Service Company to change it.

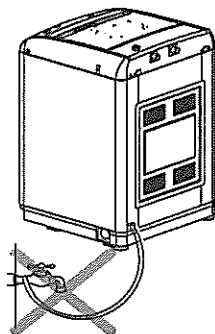
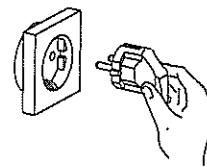

# PROGRAM

---

## DETERGENT CONTAINER

---

1. Draw out the detergent box.
2. Add the suitable quantity detergent into the detergent dispenser.
3. Add the suitable quantity softener into the softener dispenser before wash.
4. Push detergent box into completely.

Water level	Detergent dosage
	(g)
7 ~ 8	80 ~ 100
5 ~ 6	70 ~ 80
3 ~ 4	50 ~ 70
1 ~ 2	45 ~ 50

Note:

- \* Dilute concentrated detergent with triplicate water.
- \* If detergent needed, do not open the wash lid when spin, or else the softener will be premature used and the effect will be worse.

### SOFTENER FOR LAUNDRY

Note:

- \* Inject softener into the softener dispenser before washing, At the last time for rinse, the softener will be infused into the rinsing automatically.
- \* Dilute concentrated softener with triplicate water.
- \* If softener needed, do not open the wash lid when spinning, or else the softener will be prematurely used and the effect will be awful.

Water level	Softener dosage	
	Normal	Concentrated
1-2	14	5
3-4	20	7
5-6	25	10
7-8	30	13

# OPERATION

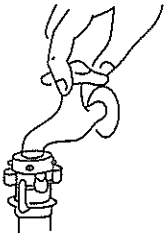
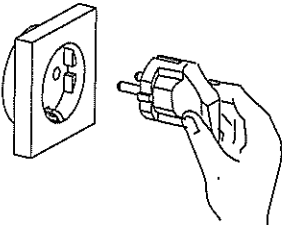
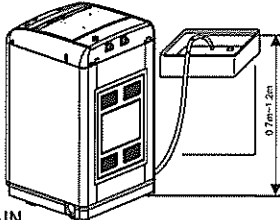
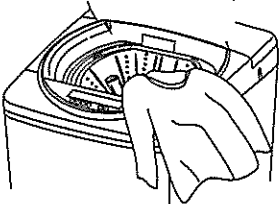
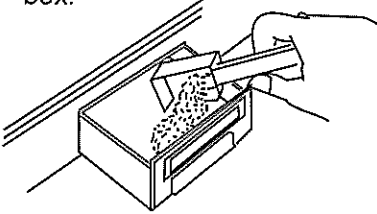
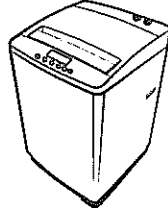

## Preparation

- Before adding clothes to the wash-always empty garment pockets of coins & other materials, as this may void the warranty.

<p>1. Connect the water inlet hose to the water faucet. 2. Turn on the water faucet.</p> 	<p>3. Plug in the power cord.</p> 	<p>4. Insert the end of the drain hose into the hook shelf, and hang the drain hose over a drain outlet.</p>  <p>UP DRAIN</p>
<p>5. Put suitable wash load into the inner tub.</p> 	<p>6. Add suitable detergent according to the wash load volume into the detergent box.</p> 	<p>7. Close the lid or the machine will not operate. <b>DO NOT FORCE THE LID TO CLOSE</b> as the soft close operation will be damaged.</p> 

## OPERATION

Step one: Choose program.  
Keys can be freely selected by the program "QUICK", "STANDARD", "TUB CLEAN", "AIR DRY", several automatic procedures.

STANDARD    QUICK    TUB CLEAN    AIR DRY



### NOTE:

The time of air dry can be selected by pressing this button after choosing program.



Timing: 30 -- 60 -- 90 -- 10 -- 20 (min)

# OPERATION

## Step Two: Choose function.

### STEP TWO: CHOOSE FUNCTION.

Press "Process" to choose any combination of dehydration".

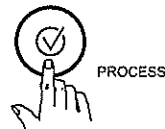

### STEP THREE: CHOOSE THE WATER LEVEL.

Press the WATER LEVEL button to choose appropriate water level according to wash quantity and then the corresponding indicator blink.

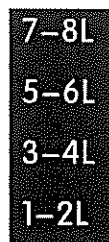

### STEP FOUR: CHOOSE WATER SUPPLY

Press the water supply button, you can choose to inlet cold water, warm water or hot water.

#### Note:

Hot water only: Hot water can result in better cleaning effects. But it is not suitable for all articles. It is best for washing whites and colorfast articles, heavily soiled articles and diapers.

Warm water only: Warm water can reduce the chance of fading. It suits for washing light and moderate soils clothes, dark color clothes, silks, woolsens, nylon, and acrylic.

Cold water only: Cold water is less effective in cleaning compared with hot or warm water, but it does minimize wrinkling and fading. Use it for washing extra sensitive clothes and for the rinse.

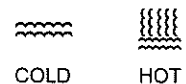

#### NOTE:

The washing machine will provide a cold rinse in all TEMPERATURE setting.

#### IMPORTANT:

There is not heating element in the washing machine. A single hose system does not allow the washing machine to automatically (choose) regulate incoming water temperatures to match those listed on the control panel such WARM or HOT.

# OPERATION

Step Five: Start the washing machine

Preset function can finish the program after a delay of some time.

05

After choosing the program above-mentioned, press the "PRESET" button (before press the "START/PAUSE" button) continuously the digital indicator indicates the desired time to finish wash. Example: If the preset time is 5 hours, press the button until the digital indicator displays 5.



Step Six: Start the washing machine

Press "START/PAUSE" button, the washing machine will buzz and run automatically. Close the lid, or the washing machine will not operate.

Note:

If you want to change the program when the washing machine is running, you must press the "START/PAUSE" to hold at first.

The water level can be changed when the washing machine is running. If you change the water level to the higher one, the washing machine will stop running and fill water to match the level you choose and then begin running again automatically.

## PROGRAM

\* Microcomputer controlled board assembly saved up 8 kinds of washing programs, please refer to the following washing program form.

### WASHING PROGRAM FORM

FUNCTION PROGRAM	SOAK (MIN)	WASH (MIN)	RINSE (MIN)	SPIN (MIN)
FUZZY	Select the time according to the quantity and quality of the wash laundry itself.			
STANDARD	15	12	15	6
QUICK		9	6	4

Note: 1.The total operating time may vary according to water volume, tolerance is permitted.

2.In case the unbalance of laundry trigger the safety switch into action when spinning, the machine will automatically refill water to adjust the balance.

# MAINTENANCE

## Clean the filter in the inlet valve

Clean the filter in the inlet valve regularly in order to prevent it from clogging

1. Unplug the power cord first.

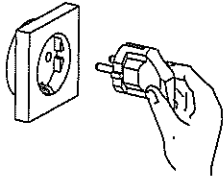

2. Take off the inlet hose and clean the filter with a brush.

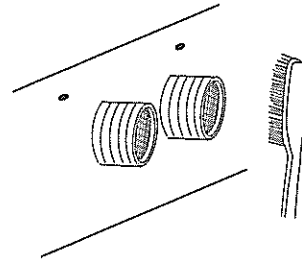

## Clean the lint filter regularly after every wash

1. Please pull out the lint filter according to the direction of arrow.



2. Firstly, open the lint filter, and then close it after cleaning and rinsing thoroughly.

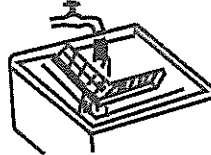

3. Reinstall the lint filter according to the direction of arrow.

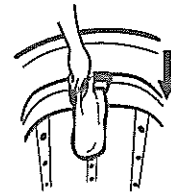
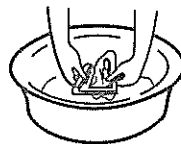
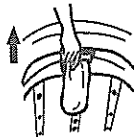
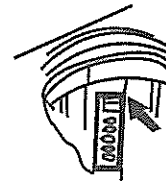







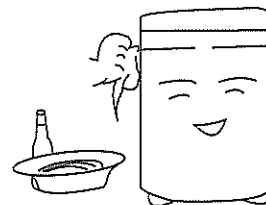

## Body Maintenance

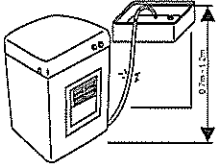
### Note:

- Clean the surface of the washing machine with a soft cloth regularly.
- After spinning each time, please clean the inner tub to avoid deposit.

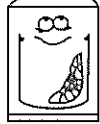
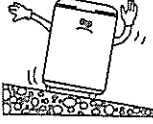

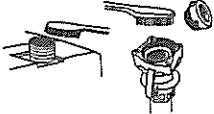
# TROUBLE SHOOTING

Problem	Checklist		
<p>Unable to drain </p> <p>If the draining time passes 10 min, the washing machine will buzz and indicate "E1".</p>		<p>Is drain hose placed properly from 0.7m to 1.2m above floor level?</p> <p>Is the drain iced or blocked?</p>	
<p>Spin malfunction </p> <p>If the machine does not spin after draining, it will buzz and indicate "E3".</p>	 <p>Is the lid closed completely?</p>	<p>Please call the technician to check whether the safety switch is damaged or not.</p>	
<p>Unable to Spin </p> <p>The machine will attempt to spin three times, if unsuccessful it will buzz and indicate "E2".</p>	 <p>Is the load uneven?</p>	 <p>Is the machine installed on an uneven surface?</p>	<p>Please call the technician to check whether the safety switch is damaged or not.</p>
<p>Failed to fill with water </p> <p>When water filling passes 20 min. It will buzz and indicate "E0".</p>	 <p>Is the tap turned off? Is there no water supply? Is the water flow too slow?</p>	 <p>Is the filter in the tap connector or inlet valve blocked?</p>	<p>Please call the technician to check whether the safety switch is damaged or not.</p>
<p>The machine gives alarm for about 10 seconds when the start / pause button be pressed. </p>	<p>Call technician to check whether the connection of water level sensor loosened or the sensor damaged.</p>		

NOTE: If you open the lid while the machine is running, all operations will be stopped within 7 seconds. To resume operation, close the lid gently.

Please turn off the washing machine first if it buzzes, and analyze issue. Do not try to fix the washing machine as it will void the warranty. Always call the service personnel to notify the issue.

Note: Please cut power supply off if there is strange noise, burning smell or smog and inform the service personnel to check.

# ELECTRICAL DIAGRAM

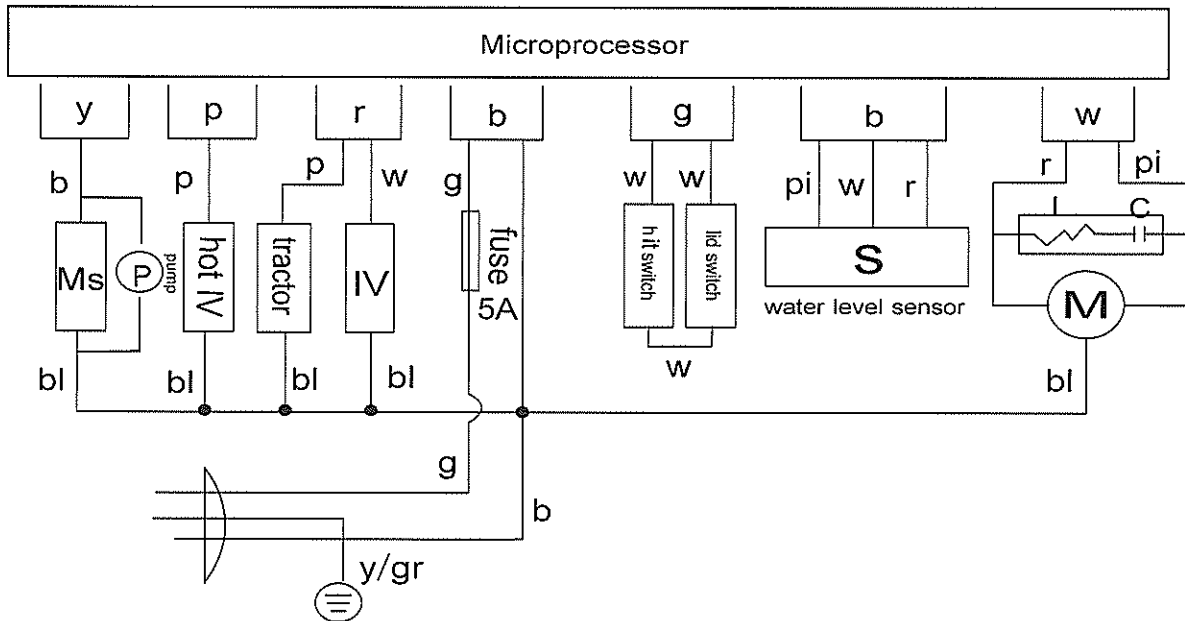

b-blue bl-black br-brown g-gray gr-green r-red w-white y-yellow p-purple pi-pink  
 C-capacitor L-inductance IV-inlet valve Ms-drain water motor assembly

## CAUTION:

- The appliance is not intended for use by young children or infirm persons without supervision;
- Young children should be supervised to ensure that they do not play with the appliance.
- The power supply cord must be unplugged after use.
- Please use low foam powdered laundry detergent.
- If the supply cord is damaged, it must be replaced by the manufacturer, its service agent or similarly qualified persons in order to avoid a hazard.
- This appliances is not intended for use by persons(including children)with reduced physical sensory or mental capabilities, or lack of experience and knowledge , unless they have been given supervision or instruction concerning use of the appliance by a person responsible for their safety.
- The instruction for appliances connected to the water mains by detachable hose-sets supplied with the appliance are to be used and that old hose-sets should not be reused.
- The washing machines has ventilation openings in the base,these openings must not obstructed by a carpet.
- The maximum mass of dry cloth which may be used in the appliance is 8 kg.
- The program "Normal", "Soak" process is off ,water supply is "Warm/Cold", water level is "8" is the one recommended for a normally soiled cotton load at the rated load capacity