

HELLER

Instruction Manual

40cm

Pedestal Fan (Black)

Model: PF40B



READ AND SAVE THESE INSTRUCTIONS

Please read and follow the instructions in this user manual even if you feel you are familiar with the product, and find a place to keep it handy for future reference.

For your convenience record the complete model number (located on the product identification plate) and the date you received the product, together with your purchase receipt and attach to the warranty and service information. Retain in the event that warranty service is required.

NOTE: The rating of this product (as marked on the product identification plate) is based on specific loading tests. Normal use or the use of other recommended attachments may draw significantly less power.

IMPORTANT SAFEGUARDS

When using any electrically powered product, basic safety precautions should always be followed, including the following:

PLEASE READ ALL INSTRUCTIONS CAREFULLY BEFORE USING THIS PRODUCT

WARNING! - to reduce the risk of fire, electrical shock or injury to persons or property:

- Always operate the product from a power source of the same voltage, frequency and rating as indicated on the product identification plate.
- Remove the unit from its packaging and check to make sure it is in good condition before using.
- Do not let children play with parts of the packaging (such as plastic bags).
- Close supervision is necessary when the product is used by or near children or infirm persons. Do not allow children to use it as a toy.
- Do not operate any product with a damaged cord or plug, or after the product malfunctions, or is dropped or appears damaged in any way. Return the complete product to the place of purchase for inspection, repair or replacement.
- Before unplugging the power cord, be sure to turn the power off. When touching the unit, be sure your hands are dry to prevent electrical shock.
- Never install the unit where it is exposed to direct sunlight, excessive moisture/rain, dust and lack of ventilation near any heat sources.
- Avoid making contact with moving parts. Never insert fingers, pencils or any other objects through the guards whenever the power plug is connected, especially while the unit is working.
- Always place the fan on a stable, level surface when operating to prevent the fan from overturning. Do not run the power cord under carpet. Do not cover the power cord with throw rugs or runners. Route the power cord away from walking paths so that nobody can trip over it. The cable should be kept away from heat, sharp edges and oil.
- To reduce the risk of electric shock, do not immerse or expose the product or flexible cord to rain, moisture or any liquid other than those necessary for correct operation of the product.
- This product should not be used in the immediate vicinity of water, such as bathtub, washbowl, bathroom swimming pool etc. Where the likelihood of immersion or splashing could occur.
- Switch off and unplug from outlet when not in use, before assembling or disassembling parts and before cleaning. Remove by grasping the plug - do not pull on the cord.
- Be sure that no other high current appliances are plugged into the same circuit as your fan, as an overload can occur.
- Avoid the use of an extension cord as the extension cord may overheat and cause a risk of fire.
- Do not use the appliance for other than its intended use.
- Do not use outdoors. **FOR INDOOR USE ONLY.**
- Do not leave the appliance unattended when switched on.

- Do not cover the grill, or operate in close proximity to curtains etc.
- The use of attachments or accessories not recommended or sold by the product distributor may cause personal or property hazards or injuries.
- This product is intended for normal domestic/household use only.
- Never leave a working appliance unattended, even for a short period of time – always switch it off. Please unplug the appliance from the power supply when not in use.
- Use this fan as described in this manual. Any other uses, not recommended by the manufacturer, may cause fire, electric shock, or injury to persons and may void the warranty.
- This appliance is not intended for use by persons (including children) with reduced physical, sensory or mental capabilities, or lack of experience and knowledge, unless they have been given supervision or instruction concerning the use of the appliance by a person responsible for their safety.
- The installation of a residual current device (safety switch) is recommended to provide additional safety protection when using electrical appliances. It is advisable that a safety switch with a rated residual operating current not exceeding 30mA be installed in the electrical circuit supplying the appliance. See your electrician for professional advice.
- **WARNING:** If the supply power cord is damaged, the power cord must be replaced by the manufacturer, its service agent or similarly qualified persons in order to avoid a hazard.
- This product has not been designed for any uses other than those specified in this booklet.
- **CAUTION:** Never insert your fingers or any other objects (hair, clothes, utensils, knives, screw drivers etc.) into the openings of the guard or close to the blade when the appliance is connected to the power supply.
- **CAUTION:** DO NOT COVER the appliance in any way in order to avoid overheating and fire.
- **CAUTION - RISK OF ELECTRIC SHOCK:** To reduce the risk of electric shock do not open this device, there are not serviceable parts for customers. Please refer any maintenance or repair to qualified personnel.

SAVE THESE INSTRUCTIONS

PARTS & FEATURES

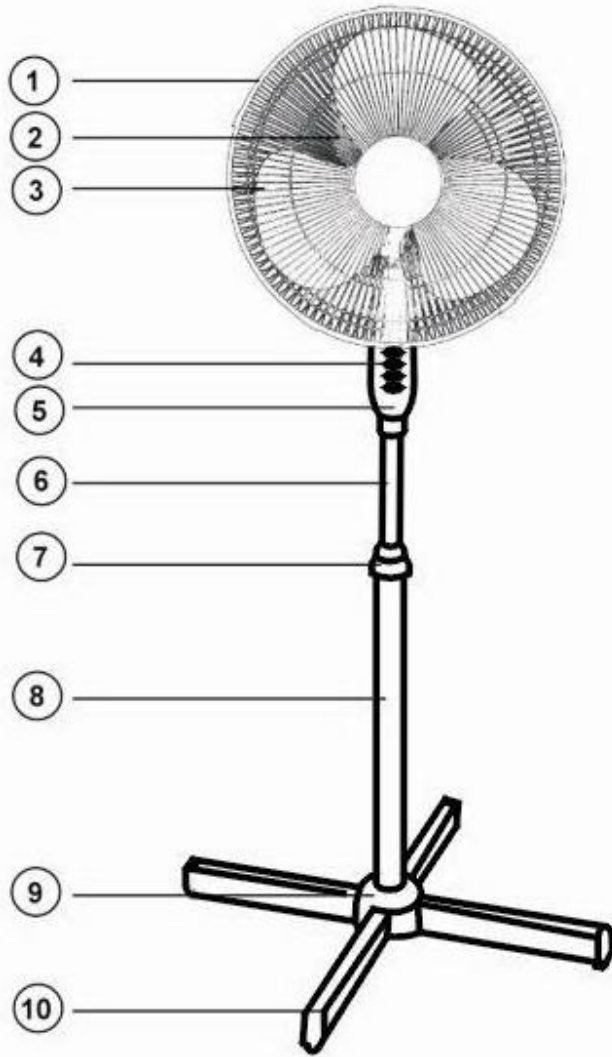

1. Grille
2. Oscillating Knob
3. Fan Blade
4. Speed switches
5. Control Panel
6. Support Pole
7. Height Adjustment Ring
8. Support Pole
9. Base Cover
10. Cross Base

ASSEMBLY INSTRUCTIONS

Ensure your fan is unplugged from the power supply before assembling.

1. Take all parts out of the box and remove any protective wrapping.

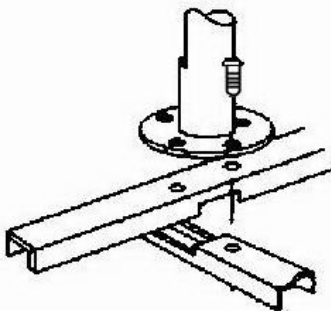

Figure A

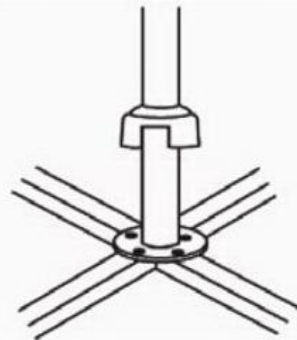

Figure B

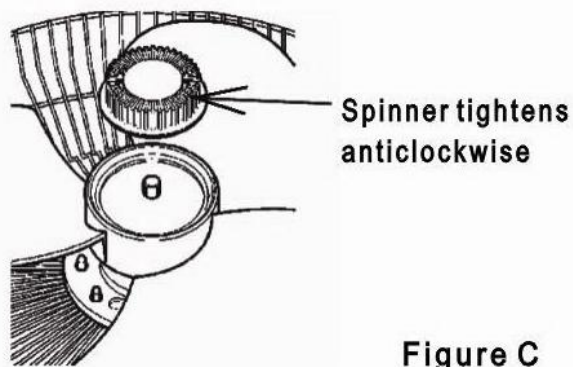

Figure C

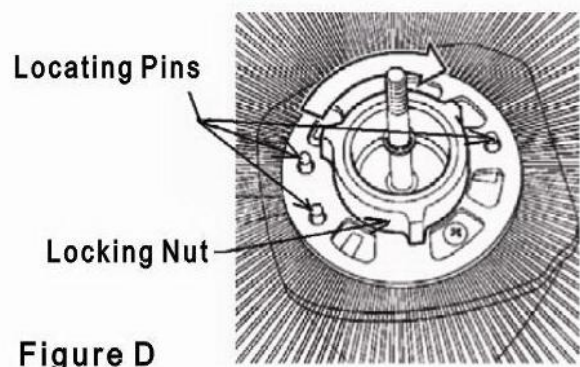

Figure D

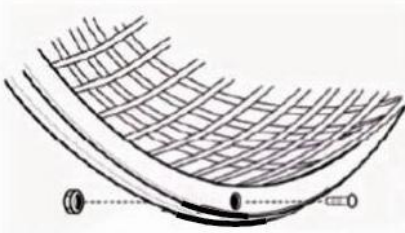

Figure E

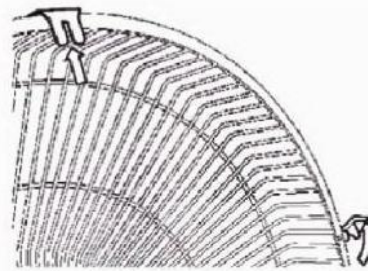

Figure F

2. Assemble the base to the support pole using the fasteners provided (see Figure A).
3. Loosen the height adjustment ring and extend the support pole to your desired height. Put the base cover over the cross base (see Figure B).
4. Tighten the height adjustment ring to prevent slipping, then put the fan assembly onto the support pole and tighten the support pole screw manually.
5. To assemble the grille and blade, remove the spinner by turning it clockwise (see Figure C), remove the fan blade and then remove the locking nut by turning it clockwise (see Figure D) from the motor shaft.
6. Put the rear grille into position. Ensure the rear grille fits onto the locating pins (see Figure D). If the grille is installed correctly, the rear grilles support handle should be on top (see Figure F). Then fix the rear grille using the locking nut.
7. Put the fan blade on the motor shaft and tighten the spinner anticlockwise.
8. Put the front grille onto the rear grille, fix with the locking clips then fasten the grille screw (see Figure E).

BEFORE FIRST USE

Before use, remove all packaging and inspect the appliance for any damage. If there appears to be any damage, please take the unit back to place of purchase for a replacement.

OPERATING INSTRUCTIONS

NOTE: Before inserting the plug into a power outlet, make sure that the correct voltage being used corresponds to what is indicated on the rating label, and that the socket has an earth facility.

CAUTION:

- Select a suitable location for the unit. Always choose a safe location in accordance to the safely recommendations outlined.
- The fan should always be switched off when making any adjustments to the fan head angle.
- Always keep the unit upright.

SWITCH

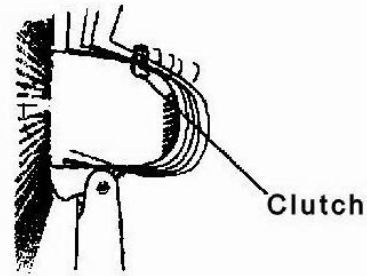
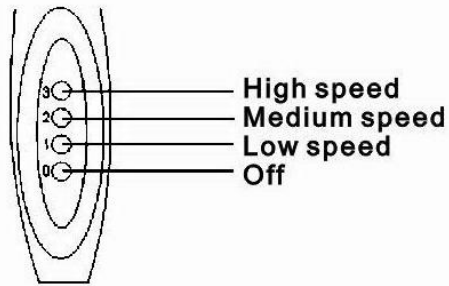

1. Place the fan on a stable, level surface.
2. Press the speed button to select the speed of the fan from LOW, MEDIUM and HIGH, in order to turn the fan ON.

The fan speed is controlled by pressing the switch:

- 0 – OFF
 - 1 – LOW
 - 2 - MEDIUM
 - 3 – HIGH
3. To start the oscillating function, push down the oscillating knob located on the top of the motor housing. To stop the fan from oscillating, pull the oscillating knob up.
 4. The fan and motor assembly are attached to a 4-position ratchet. Tilt up or down until the assembly clicks into the desired position.
 5. To adjust the height of the fan head, loosen the height adjustment locking nut, then adjust to the desired height and then tighten the nut.
 6. Press "0" button to switch the fan OFF.

CARE & CLEANING

NOTE: If the power cord set of this appliance becomes damaged, discontinue use. Repairs should be undertaken only by a qualified technician.

CAUTION: To avoid of electric shock, you must always switch off and unplug the unit before cleaning.

- Your appliance must be switched OFF via the main power supply and unplugged before proceeding with any cleaning.
- Clean the housing with a damp cloth, a vacuum cleaner or a dusting brush.
- We recommend lightly running a vacuum cleaner brush nozzle over the fan grill to remove any dust or dirt that may have accumulated.
- Never use flammable or abrasive cleaning agents such as benzene or spirits to clean the appliance.
- Never immerse the appliance in water!
- Avoid all other types of detergents, cleaners, solvents that may contain chemicals, which could damage parts of the unit.
- If the unit will not be used for a long period of time, store in a dry place.

SPECIFICATIONS

Model	Description	Voltage	Frequency	Wattage
PF40B	40cm Pedestal Fan (Black)	220-240V~	50/60Hz	60W

CUSTOMER SERVICE

Australian Customer Service

GAF Control (Sales) Pty Ltd

P.O Box 19

Altona North Victoria 3025

Phone: 1300 659 489

Hours: 9am-5pm (EST) Mon-Fri

www.gafcontrol.com.au

*This product may vary slightly to the product illustrated due to ongoing product development.