

User Manual for 221L Frost Free Refrigerator

HFF221W & HFF221S

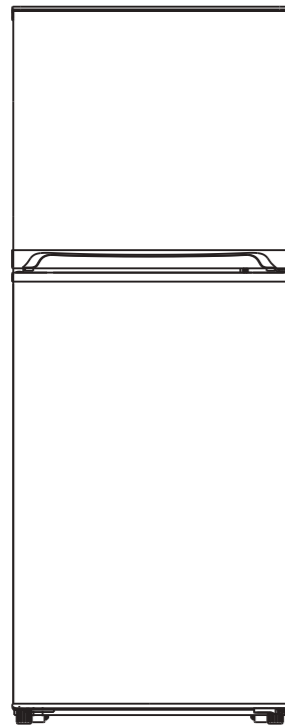

Please read this User's Manual carefully before you using the product

Thank you for purchasing our refrigerator-freezer.

Please note:

- Before using, please pay attention to the Precautions of safe use.
- Please properly keep the User's Manual after reading for later consult.
- For our products are keep continuous improved, there will no future notice if there is any change.

Content:

Parts 1

Safety Precaution 2

Placement 3

Operation check 4

Food storage 5

Maintenance 8

Trouble Shooting 9

Technical parameters and electrical diagrams 11

Packing List 12

Attention 13

Warranty 14

Kind Reminder

Dear Sir/ Madam:
The film on the door is palstic protective film.
It is so your product is not damaged during transportation.

Parts

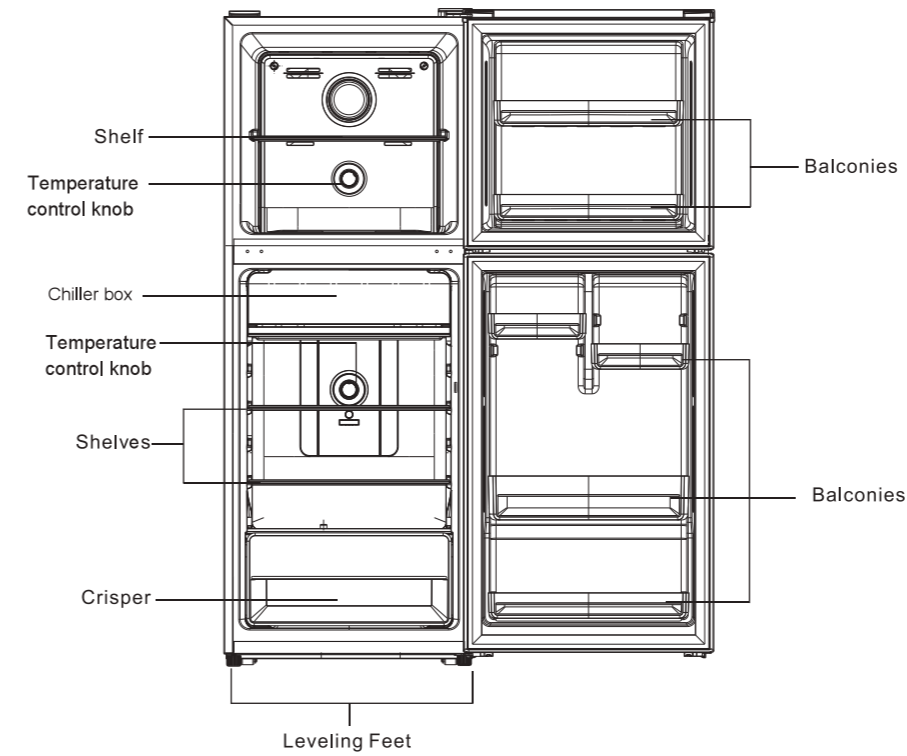

Please be subject to the actual products if anything different or updated.
Please pardon us for not informing in advance.

Safety Precaution

Please always follow the safety hint listed below:

- The power supply for the unit should be exactly the same as described on the data sheet , and use the standard tri-pong socket.
- The unit should be operated in the absence of flammable or explosive fumes. It is prohibited to put the flammable, acid or volatile goods in cabinet.
- Please unplug the unit first when you replace the light bulb or repair the refrigerator.
- Please unplug the unit immediately if you find any abnormal smell or smoke , and contact your local service center.
- Please don't allow water on the cabinet, or put a vessel full of water on the refrigerator. If the refrigerator is wet , the electrical insulation capability may be weakened.
- Hanging or sitting on the door is very dangerous, it may overturn the unit and subvert the goods in (or on) the refrigerator.
- This appliance is not intended for use by persons (including children) with reduced physical , sensory or mental capabilities, or lack of experience and knowledge, unless they have been given supervision or instruction concerning use of the appliance by a person responsible for their safety. Children should be supervised to ensure that they do not play with the appliance.
- If the supply cord is damaged, it must be replaced by the manufacturer ,its service agent or similarly qualified persons in order to avoid hazards.

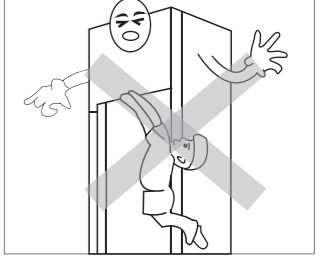
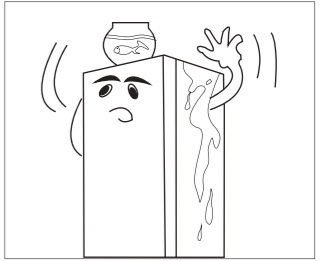
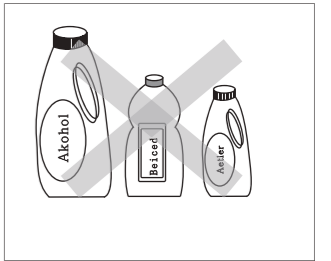
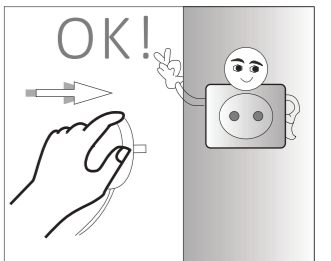

Warranty

Warranty

- Before making a claim under warranty, please refer to your user/installation manual to ensure that you have followed the correct operation procedures of your product, and refer to the trouble shooting section to assist solving any problems you may have.

Contact information:

• Australian customer service
GAF Control (Sales) Pty Ltd
P.O Box 19
Altona North Victoria 3025
Phone: 1300 659 489
Hours: 9am-5pm (EST) Mon-Fri
www.gafcontrol.com.au

Placement

The unit should be placed in a ventilated and dry environment. Do not put the unit in direct sunshine, and keep it as far as possible from heat sources.

The unit should be placed on flat and steady ground. Keep the unit level by adjusting the front leg levelers.

Don't put the unit in cold area. The appliance shall not be exposed to rain.

There should be enough spare space around the unit as shown, to allow proper ventilation.

Operation Check

- Make sure the unit has been placed properly and all instructions have been observed.

- Adjust the control knob to the middle position, and then plug in the unit. After closing the door for several minutes, both side of cabinet becomes warm.

- 30 minutes later, open the freezer compartment door, feel the cold air, that means the unit works properly. After a period of time the thermostat will switch off & on automatically and set the compartments at the desired temperature.

Food Storage

- The temperature in the fresh compartment is between 0 ~ 10°C, for the optional chill compartment, the temperature will be lower 3~4°C than fresh compartment, although this lower temperature can limit the bacteria propagation, it is not suitable for a long period of food storage.

- Cooked food should be cooled down to room temperature before putting into the refrigerator.

- It is better to put the food in a sealed bag before placing into the refrigerator.

- In order to keep vegetables fresh in the crisper, any water should be removed first, otherwise the vegetables may spoil. If you put the vegetables in a bag, they may be stored for a longer period.

Using the Control Panel Freezer compartment Temperature Setting

- Plug on your appliance. The internal temperature is controlled by a sensor. There are 3 settings **COLD, RECOMMENDED** and **COLDEST**. **COLD** is warmest setting and **COLDEST** is coldest setting.
- The appliance may not operate at the correct temperature if it is in a particularly hot or if you open the door often.



Fridge compartment Temperature Setting

- Plug on your appliance. The internal temperature is controlled by a sensor. There are 4 settings **OFF, COLD, RECOMMENDED** and **COLDEST**. **COLD** is warmest setting and **COLDEST** is coldest setting and **OFF** is off.
- The appliance may not operate at the correct temperature if it is in a particularly hot or if you open the door often.
- Neither fridge or freezer compartment works when the setting is OFF.

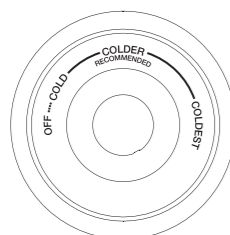

Attention:

- This product is of SN/N/ST/T climate. In case of ambient temperature lower than 10°C, storage temperature inside fridge will be affected somewhat. In order to achieve favorable storage temperature, it is recommended to set the thermostats of both fridge and freezer compartments at **COLDER** and **MAX** level.
- Changing either control will have some effect on the temperature of the other compartment.

Frozen Food Storage

- The temperature of the freezer is colder than -15°C. It is to store food to be kept for a long period.

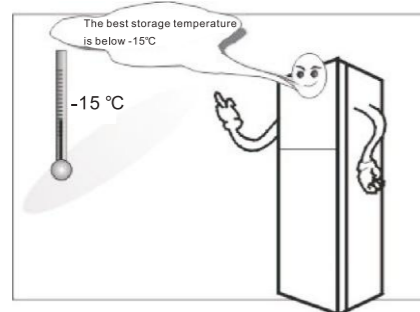

6

- Any hot food must be cooled down to room temperature before it is put into the freezer.

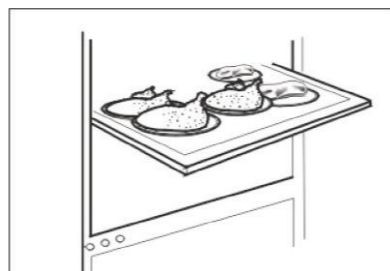

- Please don't put glass containers filled with liquid into the freezer compartment as the glass may break.

- It is better to presort the foods before putting them into the freezer. put the same kinds of food together to help to minimize the time of the freezer door opening when you take the food out, and helps to save energy.

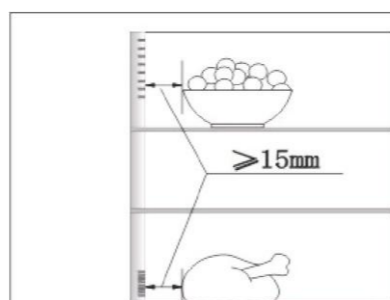

- The food should not be put too close to the outlet or inlet of the airflow. It may affect the air circulation.

Ice Tray

- The ice tray is to make ice cubes.

- Fill with cold drinkable water to a height of four-fifth of the ice tray, and place it in the freezer for about 2 hours.

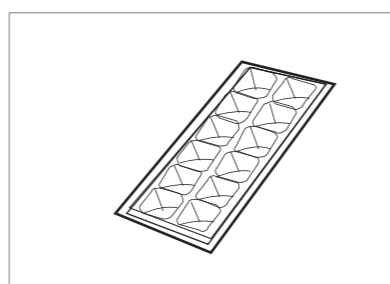

- When the cubes are fully frozen, take the ice tray out and twist it back and forth to separate the ice cubes. Don't over-bend the ice tray to avoid breaking it.

7

Cleaning

- Always unplug the unit before cleaning.
- The unit should be cleaned frequently both inside and outside using water and a little neutral detergent. Never use boiling water, harsh cleaning agents, acid, alkali or benzene etc.

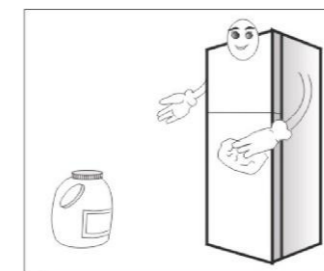

Water Pan Cleaning

- The water pan is located in the back of cabinet. Its function is to collect and evaporate the defrost water. Usually it doesn't need special care, but if you find some water overflow or odd smell, it may need to be checked and cleaned. Pull out the power cord first. Lift the water pan up a little, and then pull it straight out carefully. (Caution: make sure the discharge pipe is not too hot). After cleaning, refix the water pan into the original position. Make sure that the pipe is on top of the water pan before you push it into the original position.

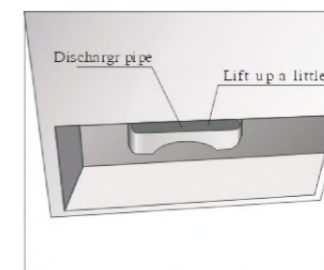
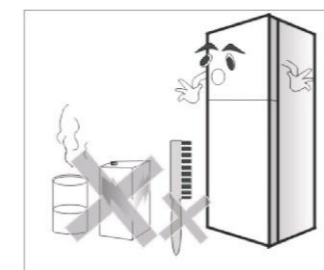

Leaving The Unit Switched Off

- If the unit will be switched off for a long time, the plug should be pulled out, then clean the unit thoroughly. Ensure that the door cannot be fully closed (leave a suitable gap), and place the unit in a well-ventilated area to avoid any door.

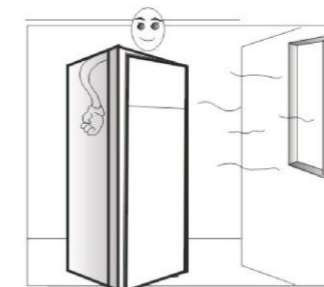

8

Before calling for service, please check the following issues first:

The reason of the trouble

Trouble	Possibility
The unit doesn't work	<ul style="list-style-type: none"> • Power is not on. • Low voltage. • The control knob is set at "OFF".
The inside temperature is higher	<ul style="list-style-type: none"> • The control knob is set at the min or warm position. • Too much food in the unit. • Hot food in the unit. • Door opened & closed too frequently. • There is a heat source nearby. • The unit is exposed to direct sunlight.
Noise	<ul style="list-style-type: none"> • Floor is not flat, and the unit is not placed steadily. • Contents are not placed in the right position.
Food frozen	<ul style="list-style-type: none"> • Is the control knob set at proper position? Too high? • Is the food near the outlet of cold draught.

9

Following Phenomenon Is Normal

- The sound like a rivulet is caused by the refrigerant flowing inside of the system pipe.
- While the unit runs, heat is emitted from both sides of the cabinet.
- When the environment is too humid, the edges around door may have a little moisture, wipe it with a dry cloth.

Warning

- This appliance is intended to be used in household and similar applications such as:
 - staff kitchen areas in shops, offices and other working environments;
 - farm houses and by clients in hotels, motels and other residential type environments;
 - bed and breakfast type environments;
 - catering and similar non-retail applications.
- This appliance is not intended for use by persons (including children) with reduced physical, sensory or mental capabilities, or lack of experience and knowledge, unless they have been given supervision or instruction concerning use of the appliance by a person responsible for their safety. Children should be supervised to ensure they do not play with the appliance.
- The appliance has to be unplugged after use and before carrying out user maintenance on the appliance.
- If the supply cord is damaged, it must be replaced by the manufacturer, its service agent or similarly qualified persons in order to avoid a hazard.
- Do not store explosive substances such as aerosol cans with a flammable propellant in this appliance.
- **WARNING:** Keep ventilation openings, in the appliance enclosure or in the built-in structure, clear of obstruction.
- **WARNING:** Do not use mechanical devices or other means to accelerate the defrosting process, other than those recommended by the manufacturer.
- **WARNING:** Do not damage the refrigerant circuit.
- **WARNING:** Do not use electrical appliances inside the food storage compartments of the appliance, unless they are of the type recommended by the manufacturer.
- **WARNING:** The lamp is not replaceable by anyone other than an authorised service person.
- For appliances which use flammable insulation blowing gases, the instructions shall include information regarding disposal of the appliance.

IMPORTANT DISPOSAL INSTRUCTIONS

As a responsible retailer we care about the environment. As such we urge you to follow the correct disposal procedure for your product and packaging materials. This will help conserve natural resources and ensure that it is recycled in a manner that protects the health and the environment.

You must dispose of this product and its packaging according to local laws and regulations. Because this product contains electronic components and sometimes batteries, the product and its accessories must be disposed of separately from household waste when the product reaches its end of life. Contact your local authority to learn about disposal and recycling. The product should be taken to your local collection point for recycling. Some collection points accept free of charge.

We apologise for any inconveniences caused by minor inconsistencies in these instructions, which may occur as a result of product improvement and development.

10

Model No	HFF221S
Group	ST, Refrigerator-Freezer
Total Gross Volume(L)	221
Total Storage Volume(L)	197
Protection Against Electric Shock	I
Refrigerating Mode	No Frost
Rated Voltage/Frequency	220-240V ~50Hz
Rated Power(W)	150
Rated Current(A)	1.2
Lamp Rated Power(W)	1
Energy Efficiency Class	3.0
Refrigerant, Amount	R600a(51g)
Foaming Agent	Cyclopentane
Noise(dB(A))	≤43
Weight(kg)	46
Dimensions(W*D*H)	545x595x1417
Overall Space Required In Use(W*D*H)(mm)	575x622x1462

Parameter will change for the improvement of products and technical updating, we are sorry for that we will have no future notice about it, the nameplate at the back of the fridge shall prevail.

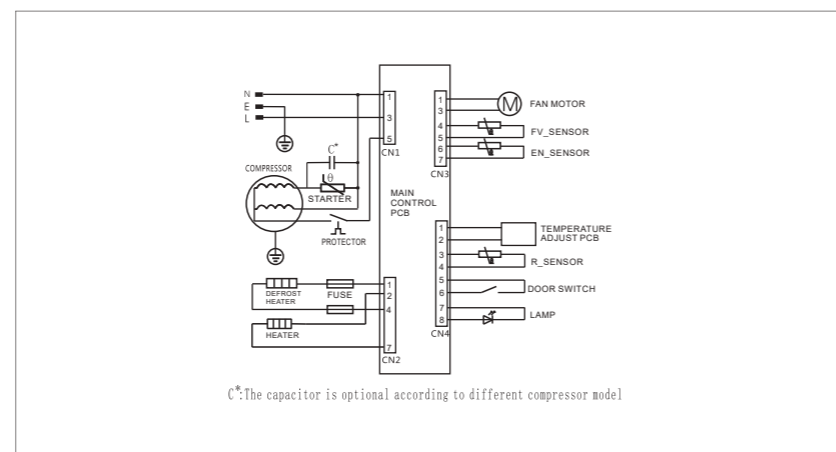

11

Packing List

Accessory Name	HFF221S
User's Manual	1
Refrigerator Glass Shelf	2
Fruit&Vegetable Box	1
Egg Holder	2
Cover Plate of Fruit&Vegetable Box	1
Freezer Door Rack	2
Refrigerator Door Rack	3
Ice Tray	1
Chill (Fresh) Box	1

12

For household refrigerating appliances

- Try not to open the door too often, especially when the weather is wet and hot. Once you open the door, mind to close it as soon as possible.
- Every now and then check if the appliance is sufficiently ventilated (adequate air circulation behind the appliance).
- For household refrigerating appliances, in normal temperature conditions, please arrange the thermostat at the middle setting.
- Before loading the appliance with packages of fresh foods, make sure they are cooled to ambient temperature.
- If it is the outer condenser, the rear wall should be always clean free of dust or any impurities.
- Always consider instructions stated in sections Positioning and Energy Saving.

R600a Refrigerant Warning

- This appliance contains a small quantity of R600a refrigerant which is environmentally friendly, but flammable. It does not damage the ozone layer, nor does it increase the greenhouse effect.
- During transportation and installation, ensure that the tubing of the refrigerant circuit is not damaged.
- Leaking refrigerant can ignite and may damage the eyes.
- In the event any damage does occur, avoid exposure to open fires and any device which creates a spark. Disconnect the appliance from the mains power.
- Thoroughly ventilate the room in which the appliance is located for several minutes.
- The room for installing the appliance must be at least 1 cubic metre over 8 grams of refrigerant. The refrigerant quantity contained in this appliance is noted on the Rating Plate of the appliance.
- It is hazardous for anyone other than an Authorised Service Person to service this appliance. In Queensland – the authorised Service Person MUST hold a Gas Work Authorisation for hydrocarbon refrigerants, to carry out Servicing or repairs which involve the removal of covers.

13